

### IDC SOCKET 2.54mm x 2.54mm

#### TECHNICAL SPECIFICATIONS

Material:	UL 94 V-0 Plastic Material
Operating Temperature:	-40°C to +105°C
Contacts:	Copper Alloy
Cable:	1.27mm (0.050") pitch flat cable
Current rating:	1 A
Withstanding voltage:	AC 500V
Insulator Resistance:	1000MΩ min.
Contact Resistance:	30mΩ max.

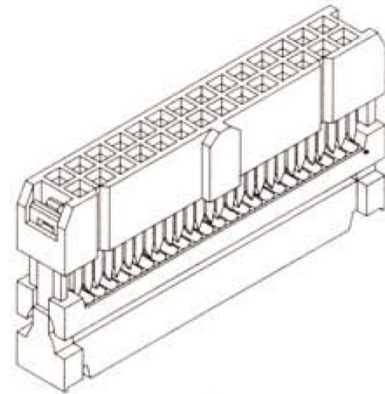

#### FEATURES

- Complete with polarizing bump
- Complete with strain relief
- Standard in black, grey available on request

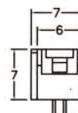
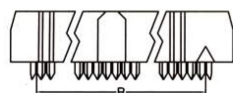
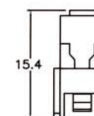
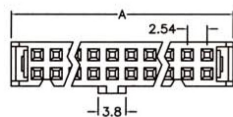
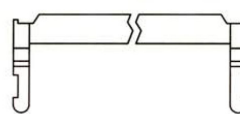
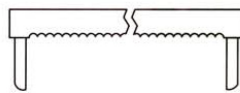
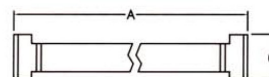
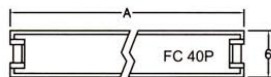

Position	Dim A	Dim B	Dim C
6	12,18	5,08	1,9
8	14,72	7,62	1,9
10	17,26	10,16	3,6
12	19,80	12,70	3,6
14	22,34	15,24	3,6
16	24,88	17,78	3,6
18	27,42	20,32	3,6
20	29,96	22,86	3,6
24	35,04	27,94	3,6
26	37,58	30,48	3,6
30	42,66	35,56	3,6
34	47,74	40,64	3,6
40	55,36	48,26	3,6
50	68,06	60,96	3,6
60	80,74	73,66	3,6
64	85,82	78,74	3,6

Part Number
FC06-SA
FC08-SA
FC10-SA
FC12-SA
FC14-SA
FC16-SA
FC18-SA
FC20-SA
FC24-SA
FC26-SA
FC30-SA
FC34-SA
FC40-SA
FC50-SA
FC60-SA
FC64-SA